

# 深圳市占開科技有限公司

ShenZhen ZhanKai Technology CO.,LTD

TEL:0769-81802125

FAX:0768-81802126

DOCUMENT NO.

RDE2008A

SERIAL NO.

A2008H00-NP

Material: Nylon 66 UL 94V-0

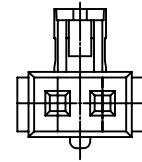
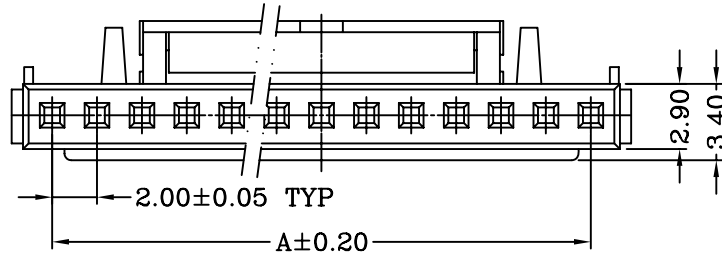

2P

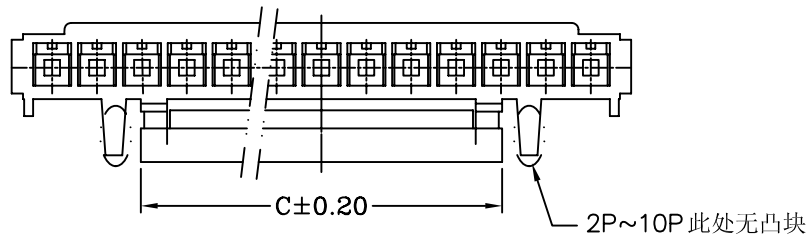
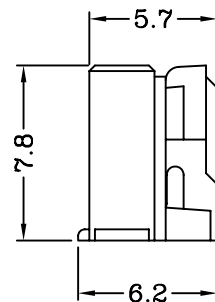
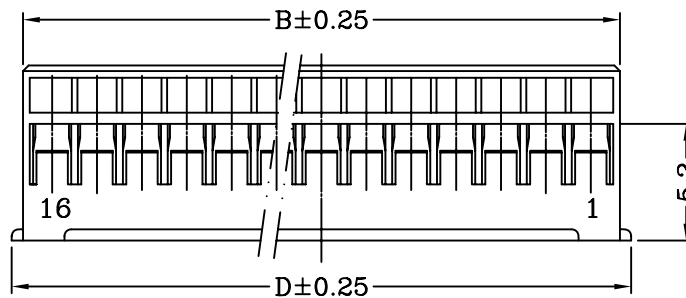

3P~15P

## Dimensional & Ordering Information:

Circuits	Part No.	Dimensions				Pcs/Bag
		A	B	C	D	
2	A2008H00-2P	2.00	4.6	2.3	5.6	1000
3	A2008H00-3P	4.00	6.6	2.3	7.6	1000
4	A2008H00-4P	6.00	8.6	4.3	9.6	1000
5	A2008H00-5P	8.00	10.6	4.3	11.6	1000
6	A2008H00-6P	10.00	12.6	8.3	13.6	1000
7	A2008H00-7P	12.00	14.6	10.3	15.6	1000
8	A2008H00-8P	14.00	16.6	12.3	17.6	1000
9	A2008H00-9P	16.00	18.6	12.3	19.6	1000
10	A2008H00-10P	18.00	20.6	12.3	21.6	1000
11	A2008H00-11P	20.00	22.6	16.2	23.6	1000
12	A2008H00-12P	22.00	24.6	16.2	25.6	1000
13	A2008H00-13P	24.00	26.6	16.2	27.6	1000
14	A2008H00-14P	26.00	28.6	16.2	29.6	1000
15	A2008H00-15P	28.00	30.6	16.2	31.6	1000

REV.	ECN NO.	UNIT	TOLERANCE	PROJECTION	DRAWING	CHECK	APPROVAL
△	NEW DRAWING	mm	*** ±0.08		余望明	—————	朱建勋
△			** ±0.15				
△			* ±0.25				

# 深圳市占開科技有限公司

ShenZhen ZhanKai Technology CO.,LTD

TEL:0769-81802125

FAX:0768-81802126

DOCUMENT NO.

RDE2008B

SERIAL NO.

A2008TOP-2

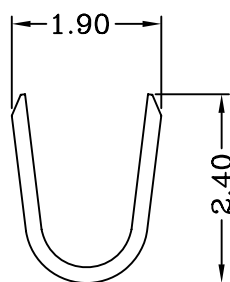
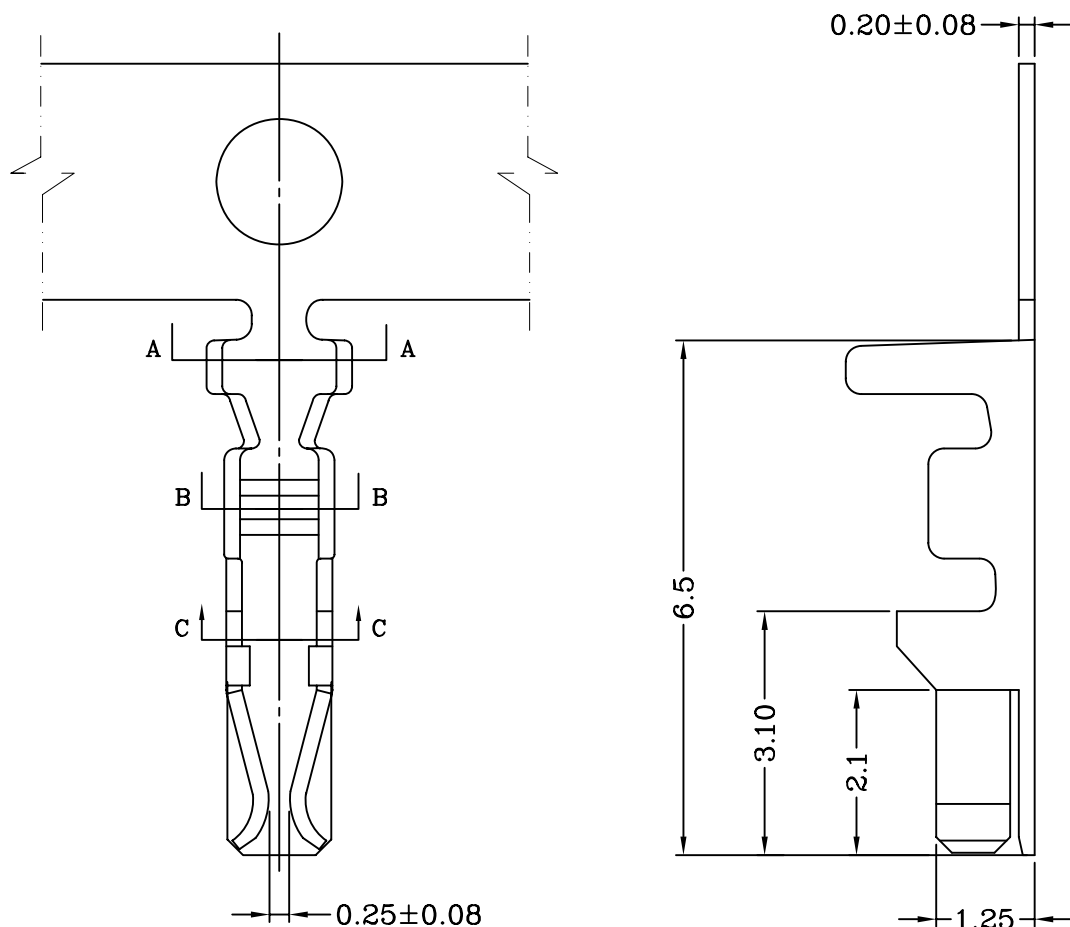

SEC:A-A

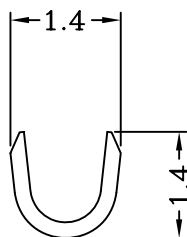

SEC:B-B

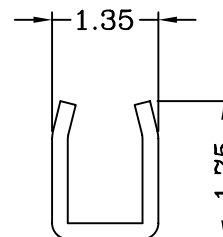

SEC:C-C

Specifications & Ordering Information:

Part No	Wire Range	Insulation O.D.	Material	Finish	Qty/reel
A2008TOP-2	AWG #22~#30	1.60mm(max)	Phosphor bronze	Tin-plated	10,000 PCS

REV.	ECN NO.	UNIT	TOLERANCE	PROJECTION	DRAWING	CHECK	APPROVAL
△A	NEW DRAWING	mm	*** ±0.08		余望明	—————	朱建勋
△B			** ±0.15				
			* ±0.25				