

# 深圳市占開科技有限公司

ShenZhen ZhanKai Technology CO.,LTD

TEL:0769-81802125

FAX:0768-81802126

DOCUMENT NO.

RDE0562A

SERIAL NO.

A1257H00-NP

Material: PBT UL 94V-0 (White)

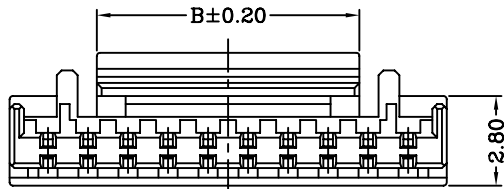

4P~15P

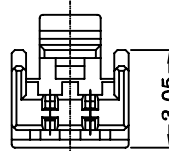

2P

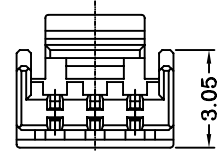

3P

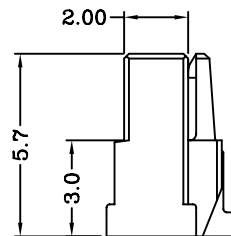
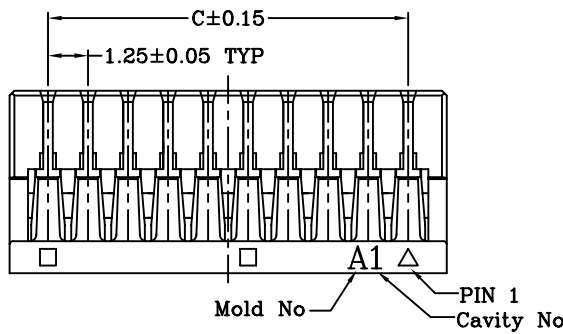

4~15P

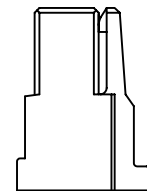

2~3P

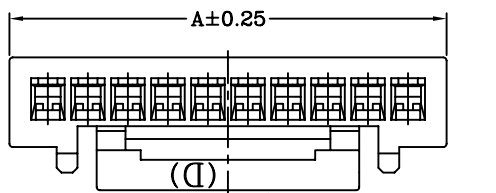

Factory Code      Company Mark

### Dimensional & Ordering Information:

Circuits	Part No.	Dimensions			Pcs/Bag
		A	B	C	
2	A1257H00-2P	3.65	2.35	1.25	1000
3	A1257H00-3P	4.90	3.20	2.50	1000
4	A1257H00-4P	6.15	4.25	3.75	1000
5	A1257H00-5P	7.40	4.25	5.00	1000
6	A1257H00-6P	8.65	6.25	6.25	1000
7	A1257H00-7P	9.90	6.25	7.50	1000
8	A1257H00-8P	11.15	6.25	8.75	1000
9	A1257H00-9P	12.40	6.25	10.00	1000
10	A1257H00-10P	13.65	8.20	11.25	1000

REV.	ECN NO.	UNIT	TOLERANCE	PROJECTION	DRAWING	CHECK	APPROVAL
A	NEW DRAWING	mm	*** ±0.08		余望明	——	邹朝辉
B			** ±0.15				
			* ±0.25				

# 深圳市占開科技有限公司

ShenZhen ZhanKai Technology CO.,LTD

TEL:0769-81802125

FAX:0768-81802126

DOCUMENT NO.

RDE0513A

SERIAL NO.

A1257TOP-2

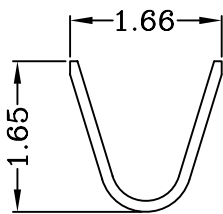
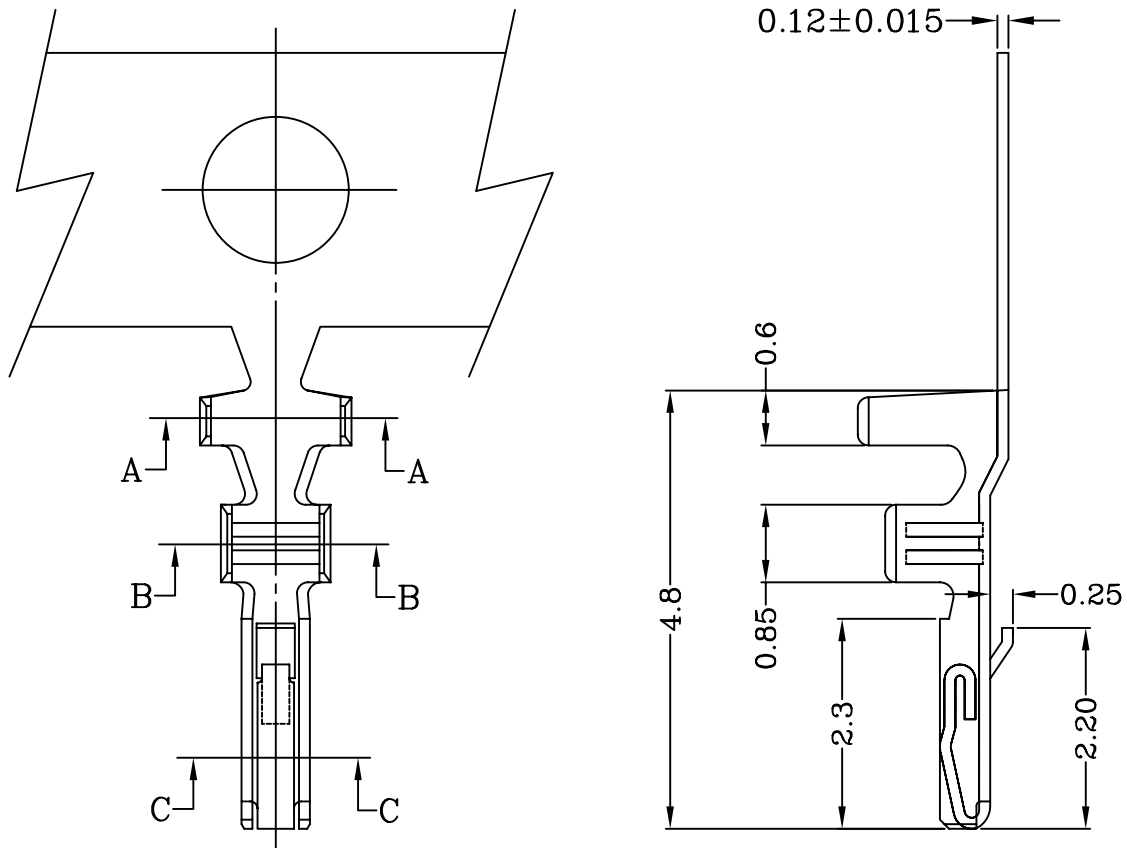

SEC:A-A

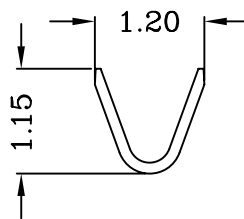

SEC:B-B

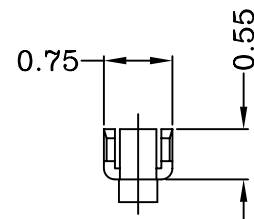

SEC:C-C

**Specification & Ordering Information:**

Part No.	Wire Range	Insulation O.D.	Material	Finish	Qty/reel
A1257TOP-2	AWG #28~#32	0.90mm(max)	Phosphor bronze	Tin-Plated	20,000 pcs

REV.	ECN NO.	UNIT	TOLERANCE	PROJECTION	DRAWING	CHECK	APPROVAL
△	NEW DRAWING	mm	*** ±0.08		余望明	——	邹朝辉
			** ±0.15				
			* ±0.25				